

Precision Cooling  
For Business-Critical Continuity

*Liebert DS™*  
*Designed To A Higher Standard Of Performance And Reliability*



# Liebert Understands The Need For Precision And Reliability... And Why This Is So Important To You

For sensitive electronics, environmental control is more than simple cooling. “Comfort” air conditioning systems are designed to cool people and office space. They simply cannot provide the kind of environment required by high performance computer or communication equipment.

## Why You Can't Take Chances When Cooling Your Critical Space

Standard building cooling systems are designed to keep people comfortable 8-12 hours each day from spring to autumn with no provision for winter operation. A precision cooling system is designed to operate over a wide range of ambient temperatures from as low as -30°F (-34.4°C) up to 120°F (48.9°C).

Sensitive electronics must be maintained in a stable environment of 68°F to 77°F (20°C to 25°C) with a relative humidity of 40% to 55%. Computers and communications equipment generate six to ten times the heat density of normal office space, the air conditioning system must have more than just enough cooling capacity. **It must have the precision to react quickly to a drastic change in heat load and prevent wide temperature fluctuations—something a large building HVAC system cannot do.**

The ASHRAE document, “Thermal Guidelines for Data Processing Environments,” spells out the temperature, dew point and humidity specifications for electronic components operating in mission-critical facilities. Types of equipment typically found in these facilities are enterprise servers and storage products.

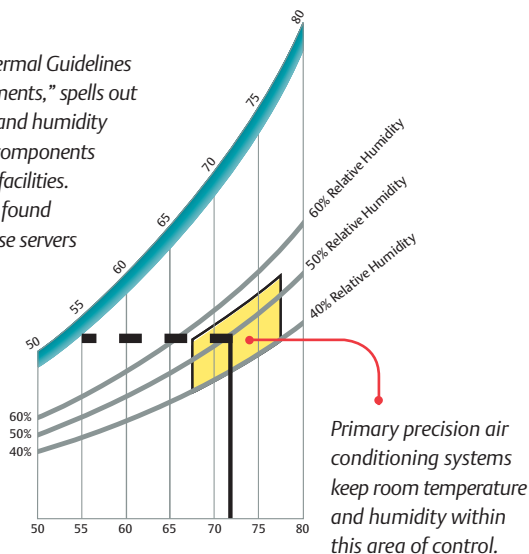

## We Have The Right Solution For Your Specific Application

Liebert has identified a number of distinct zones or areas of application found within many business-critical applications. Each zone has similarities, but with different needs for infrastructure protection—all of which can be met by Liebert solutions.

Specific zones where the Liebert DS can be used include:

- Data Centers
- Computer Rooms
- Network Operations Centers
- Telecom/CATV
- Labs And Testing
- Production Facilities

## A Tradition Of Reliability You Can Count On

Liebert Mission Critical Cooling equipment is the standard by which all others are judged. The number of units that are in the field far exceeds the combined number of all other brands. Nine out of ten Fortune 500 Companies use Liebert cooling systems.

Liebert Mission-Critical Cooling Systems are used in the most demanding, critical applications in the world. From banking to government to corporate computer and communications centers, when it has to be the best—this is the brand of choice.

## *The Liebert DS Is Designed And Built Like No Other*

### **Why You Should Specify Liebert Over Competitive Precision Systems**

Proper protection of critical facilities takes more than bolting together pre-engineered computer room cooling modules. In many cases, your critical systems are only as reliable as the support equipment protecting them. Compromising on a less capable precision cooling system can compromise your operations. Your critical operations demand support equipment that can provide the highest level of reliability.

### **Engineering Excellence Goes Into Every Liebert DS**

The Liebert DS is based on the proven design and technology of Liebert Deluxe Systems used in thousands of critical data centers around the world since 1965.

Full scale analysis and evaluation of the Liebert DS during all phases of development and production is your assurance of the most advanced performance and highest quality. Units are thoroughly tested under a wide variety of temperature and humidity conditions.



### **Reliability:**

- The Liebert DS is designed with the highest quality components selected for their proven reliability and performance.
- Microprocessor technology adds automatic sequencing of components to even wear and extend service life.
- An alarm system and self-diagnostics provide rapid troubleshooting and can prevent a problem before it affects the electronic equipment room environment.
- Air delivery system designed for optimized air distribution and long service life.
- Corrosion resistant frame and cabinet.

### **Flexibility:**

- Available in both downflow and upflow configurations to cover a wide range of room applications.
- Choice of compressors to match performance and energy efficiency requirements.
- Front access provides easy serviceability and saves valuable floor space.
- Modular frame construction allows even more flexibility in meeting specific needs for installation—frame can be field-separated into three sections.
- Built-in humidity control and reheat function.
- Liebert iCOM control system brings high-level supervision to multiple units allowing them to work together as a single system to optimize room performance.
- Available with R-407C environmentally friendly refrigerant or R-22 standard refrigerant.

### **Low Total Cost Of Ownership:**

- Energy efficiency options and configurations can save money and even pay back part of your investment over the life of the product.
- Built for serviceability, with many components—such as the Paradenser™ cleanable condenser—designed to be maintained rather than replaced.
- Specifically designed for the demanding requirements of year-round operation, the Liebert DS is actually less expensive to operate over its life cycle compared to both comfort cooling equipment and competitive precision air conditioning products.

## Engineered For Precision, Efficiency And Strength

**The Liebert DS is designed to fit room applications requiring high level precision control of the room environment, including temperature, humidity, filtration and airflow.**

### Precise Temperature And Humidity Control

The environmental control system must be able to sense and react to temperature and humidity fluctuations far too small for building HVAC systems to control. The Liebert DS is capable of control to within  $\pm 1^\circ\text{F}$  ( $^\circ\text{C}$ ) and  $\pm 1\%$  RH. By analyzing the rate of change in temperature or the moisture content in the environment, the control system anticipates what is going to happen in the room, not simply responding to what has happened.



### Designed For Energy Efficiency

Liebert is dedicated to providing maximum energy efficiency in its precision cooling systems without compromising the accuracy and reliability demanded by sensitive electronics. All enhancements to energy efficiency are designed to reduce operating time of key components and increase the Mean Time Between Failure. This is accomplished by taking advantage of alternate sources of cooling by minimizing compressor operation when heat loads in the conditioned space are lower. Energy savings is also gained through the use of high efficiency components such as advanced digital scroll and 4-step semi-hermetic compressors.

### Quality, Rugged Construction

The durable design of the Liebert DS provides a stable, virtually vibrationless platform for compressor and fan operation:

**Autophoretic® frame coating**—protects frame against corrosion for years of reliable service.

**Welded frame**—14 gauge steel provides rugged construction, proven to withstand shipping and handling through ISTA (International Safe Transit Association) certified ship testing.

**Durable powder coated exterior panels**—look good and stay that way.

**Slot and tab sheet metal**—for consistent, quality construction.

**Optional double-skin panels**—eliminate insulation in the air stream. This allows for easy panel cleaning.

**Optional floorstands**—Adjustable standard and seismic-rated floorstands allow for installation and connection of the system prior to the installation of the raised floor. Available in heights from 6" to 36", a field installed turning vane may be specified.

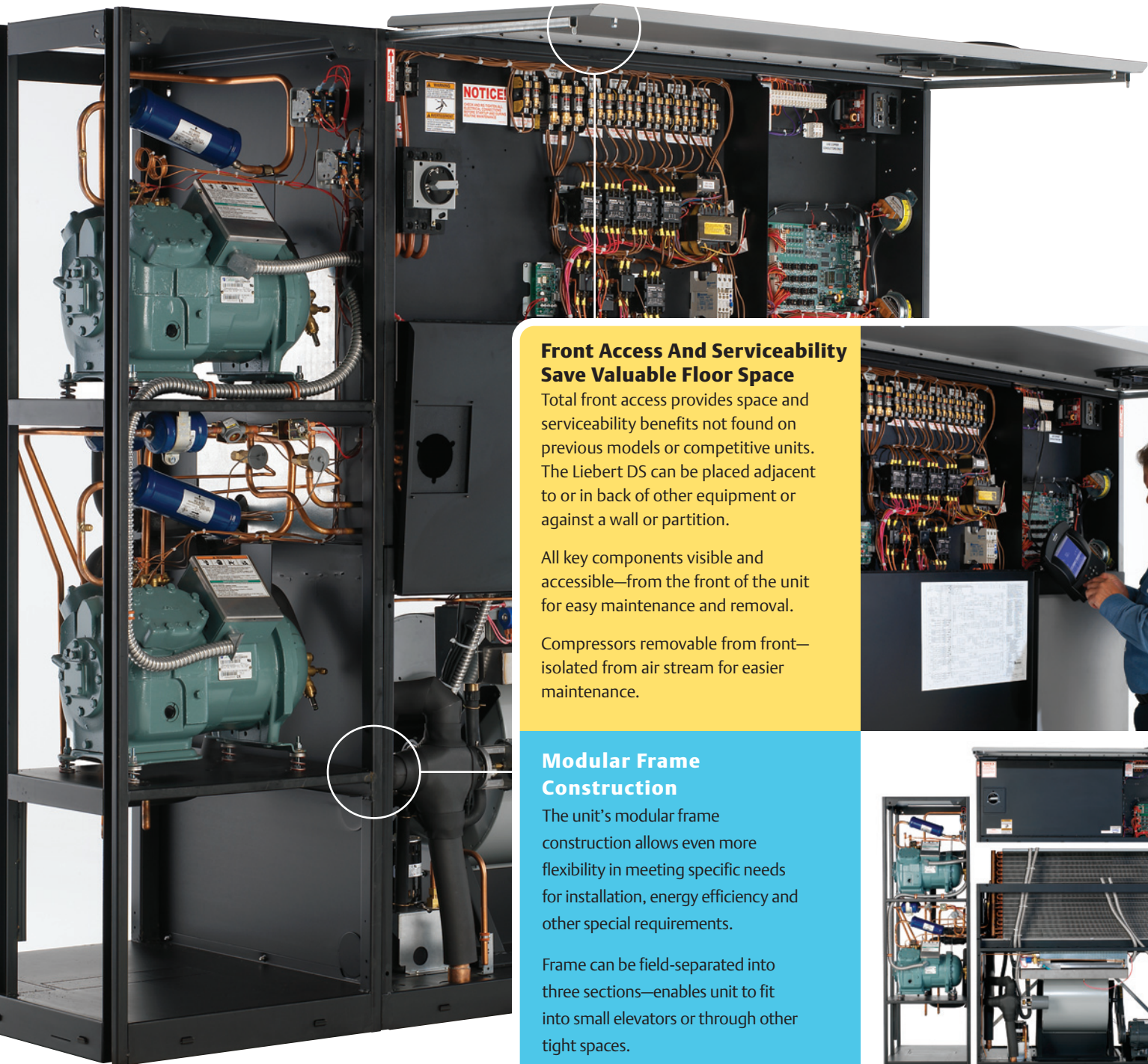

### Front Access And Serviceability Save Valuable Floor Space

Total front access provides space and serviceability benefits not found on previous models or competitive units. The Liebert DS can be placed adjacent to or in back of other equipment or against a wall or partition.

All key components visible and accessible—from the front of the unit for easy maintenance and removal.

Compressors removable from front—isolated from air stream for easier maintenance.

### Modular Frame Construction

The unit’s modular frame construction allows even more flexibility in meeting specific needs for installation, energy efficiency and other special requirements.

Frame can be field-separated into three sections—enables unit to fit into small elevators or through other tight spaces.

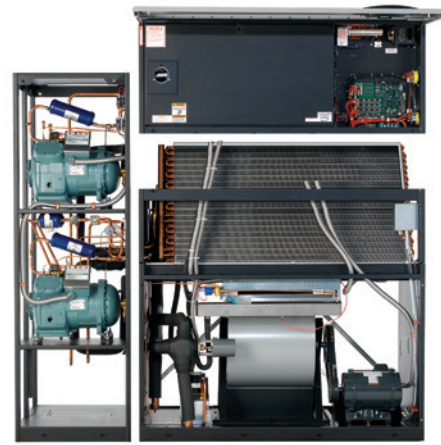

## When You Need Flexibility In Cooling Configurations

The Liebert DS provides a complete environmental control package, including both precision air conditioning as well as humidity control—no matter what the temperature is outside. Both upflow and downflow configurations are available to cover raised floor and non-raised applications.

The Liebert DS product line has been designed to cover the widest possible range of application requirements. These include choice of airflow configuration, cooling method options and many other selections that will create the most effective and efficient system for your facility.



Liebert DS Downflow

### Liebert DS Units Can Be Configured For Optimum Cooling Of Any Type Of Space

**Downflow** configurations are designed for use in raised floor applications such as data centers and other facilities housing sensitive electronic equipment. The Liebert DS downflow configuration combines top air return with bottom air supply to circulate air underneath the floor.

**Upflow** units can be specified in situations where the floors are not raised, such as communications facilities, industrial control rooms and laboratories. These units can supply air directly into the room or be connected to distribution ductwork.

### Compressorized Systems Offer Flexibility, Efficiency, Reliability

Long recognized as the standard in environmental control systems for data center operations, Liebert DS compressorized systems are built to the highest specifications in the industry with proven components and design. They feature direct expansion operation in four types of cooling configurations: air cooled, water cooled, glycol cooled and our exclusive GLYCOOL free-cooling option.



Liebert DS Upflow

## The Widest Variety Of Air Supply Choices

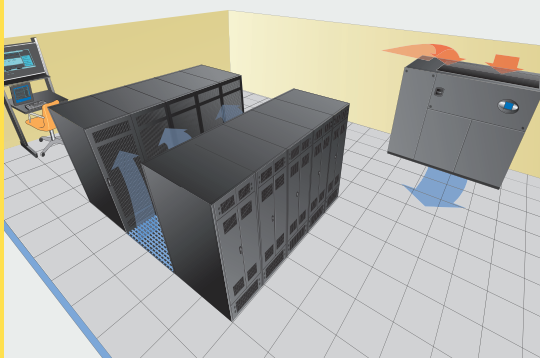

### **Downflow Supply**

Designed for raised-floor applications, the downflow air supply configuration is commonly found in data centers and other similar facilities housing sensitive electronic equipment.

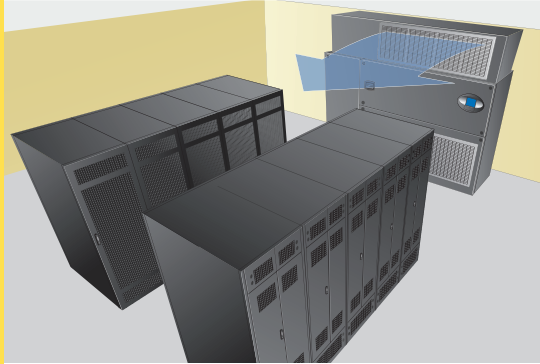

### **Top Front Supply with Plenum & Grille and Front Return**

In-the-space applications without ductwork, such as Telecommunications, Networks and Switching Centers, benefit from this economical configuration. Optional high filtration may be desirable.

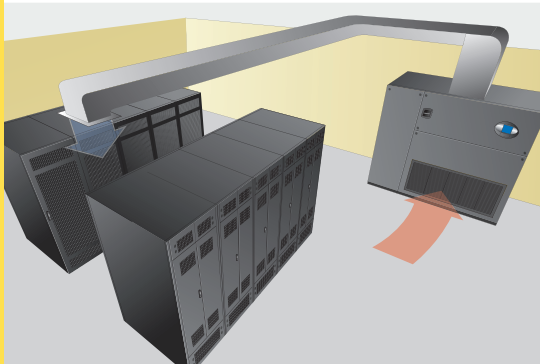

### **Top Front Supply and Front Return**

Engineered for in-the-space applications utilizing duct work, this airflow design is commonly used for Telecommunications or Industrial applications. High static pressure and filtering options may be selected.

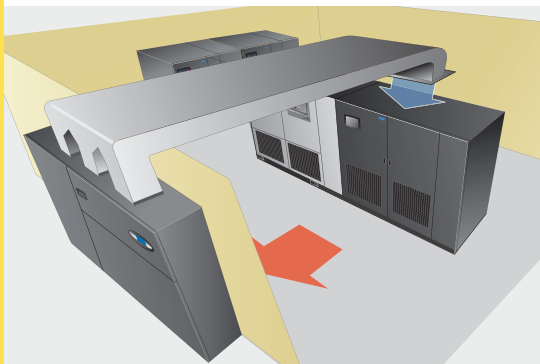

### **Top Rear Supply and Rear Return**

Designed for use in out-of-space applications, this configuration is typical for Industrial Processes such as Control Rooms, and Labs. Many of these sites will select a higher static pressure and optional high efficiency filters. (Customer ducted supply and return)

## Air Delivery System Designed For Optimized Air Distribution And Long Service Life

**5-YEAR WARRANTY** on drive components (bearings, belts, shaft, pulleys).

Centrifugal blowers enable performance over a wide range of air volume and static pressure ranges.

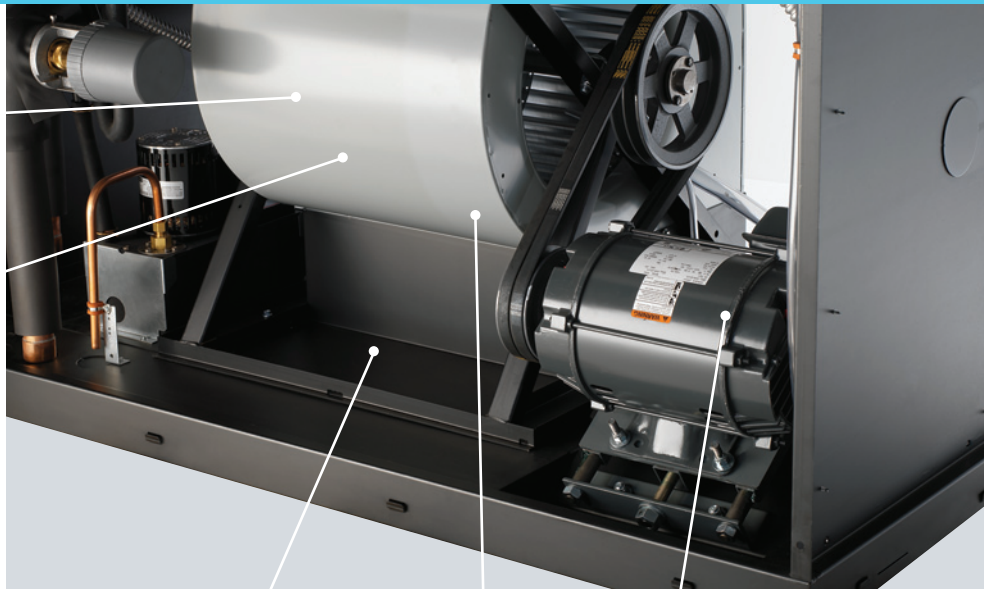

Flexibility for high filtration or external static pressures up to 2.5" (625 Pa).

Static regain duct improves underfloor air distribution.

Pillow block fan bearing with minimum L3 life of 200,000 hours.

High efficiency motor meets NEMA Premium motor standard.

Computers and other sensitive electronics require greater air volumes than comfort air conditioning can provide. The high density heat load in the relatively small space of a data center requires more air changes to remove heat properly. A key to the outstanding performance of the Liebert DS is its optimized air delivery design. It combines high efficiency and effective air handling to deliver reliable, constant cooling under the most demanding conditions.

Special 5-year Liebert Belt



### Pentadrive™ Blower system/belt tensioning:

- Automatic self-tensioning motor base increases belt life and reliability of shaft and bearings.
- Keeps constant tension on belt.
- Maintains good sheave and pulley alignment.
- Prevents over-tightening.
- Dual belts for 100% redundancy.

### Pentadrive™ Blower System

Large capacity fans are dynamically balanced to minimize vibration and provide even air distribution. The low velocity fans use less fan motor energy and operate more quietly than forced air blowers. Filtered air at the right temperature and humidity is fed positively and evenly into the room.



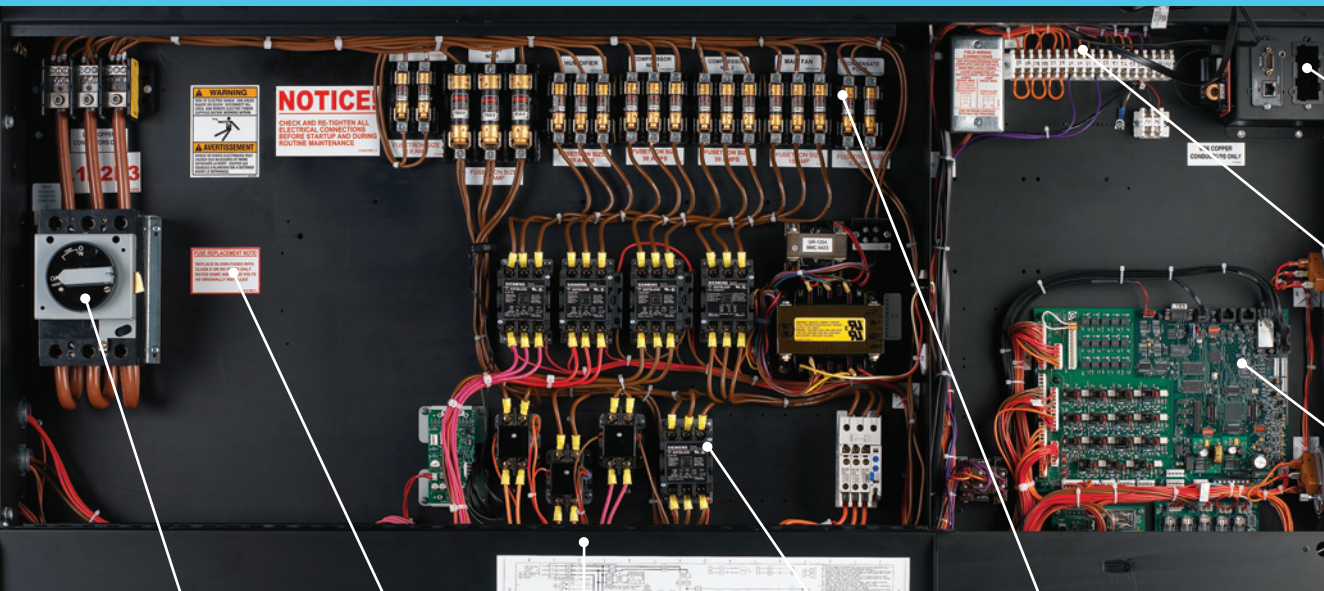

Intellislot for easy plug-in of optional communication cards.

Low voltage terminal strip provides connection flexibility.

Control interface board for easy access.

Optional disconnect switch available as non-locking or locking.

Location for optional secondary disconnect switch for non-critical loads.

Deadfront panel folds down for easy viewing of electrical schematic.

Optional solid-state contactors used on SCR reheat for tight temperature applications.

Individually-fused components high-rated fuses for maximum reliability, high interrupt rating, and cooler operating fuses for maximum reliability.

## Motors

The Liebert DS features fan motors that are optimized for reliability and energy efficiency.

**High-efficiency open drip-proof motor** meets National Electrical Manufacturers Association (NEMA) Premium motor standard.

### Motor Options

- **Optional TEFC (Totally Enclosed Fan-Cooled) motors**—for rugged industrial environments.
- **Optional larger horsepower motors available**—for higher air volume or higher static pressures.

## Electric Panel

The electric panel of the Liebert DS is designed for easy access to critical electrical and control components.

### Unit Monitoring And Control Options

- **Dual float condensate pump**—installed in unit, with secondary float to shut down unit and trigger alarm if high water detected.
- **Optional low voltage terminal package**—two extra n/o common alarm contacts, two extra remote shutdown terminals, one main fan auxiliary contact. When connected to an optional water sensor, shuts down unit and provides dry contact closure.
- **Smoke sensor**—senses the return air, shuts down the unit upon detection, and sends visual and audible alarm. Dry contacts are available for a remote customer alarm. This smoke sensor is not intended to function as, or replace, any room smoke detection system that may be required by local or national codes.
- **High temperature sensor**—alerts users to any high temperature situations within the system. Senses return air temperature and shuts down unit if temperature exceeds 125°F (51.7°C).
- **Analog input wiring**—includes four customer-accessible analog inputs for sensors provided by others. The analog inputs accept a 4 to 20 mA signal. Gains Calibration for each input are programmable from the front panel.
- **Compressor overload**—activates an audible and visual alarm in the event of a compressor overload.
- **Main Fan Overload**—activates an audible and visual alarm in the event of a motor overload.

## Dependable, Effective Cooling System

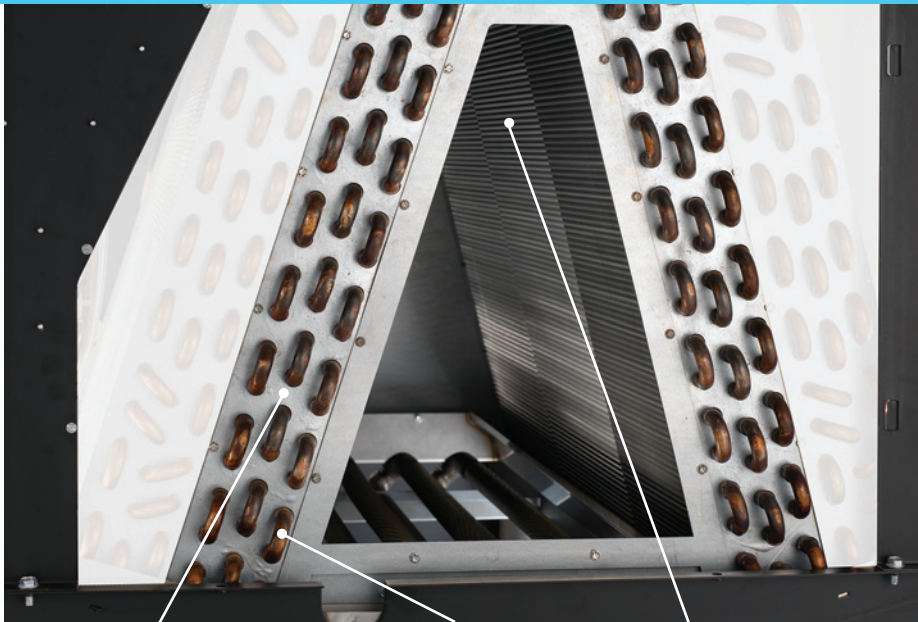

A-frame coil design maximizes coil area, reduces air velocity, lowers chance of water blowing off coil, results in far less turbulence with superior efficiencies in heat transfer.

Optional polymeric coating on coils protects against corrosion due to harsh environments.

Draw-through design pulls air evenly through the cooling coil, reheat and humidification systems.

At the heart of the Liebert DS are its cooling system components, each designed to provide maximum reliability.

### A-Frame Coil

This Liebert designed and manufactured A-Frame coil features a large face area/low face velocity design for precise control of cooling and dehumidification—and is designed to optimize heat transfer and minimize pressure drop.

### Dual Refrigeration Circuits For Redundancy

Dual compressors and refrigeration circuits assure reliability and feature automatic sequencing for even wear of components.

- **Components include** dual compressors and dual refrigeration circuits enabling the system to operate even if one circuit fails.
- **Pump-down evacuation of refrigerant from compressor crankcase** shields the compressors from the “hard starts” that can shorten their life.

### Refrigeration System Features

Each refrigeration circuit includes:

- **Sight glasses** serve as a means of quick visual inspection to determine if there is moisture in the system and if the system is properly charged.
- **Refrigerant dehydrators** assure a moisture-free refrigerant system for extended component life.
- **Expansion valves** – Externally equalized expansion valves smoothly control refrigerant flow during indoor heat loads and outdoor ambients by controlling evaporator superheat.
- **Muffler** – Specially engineered mufflers afford a quiet pulsation-free refrigeration system.
- **Safety controls** – Each compressor has an automatic reset high pressure switch which locks-out after the third trip. A low pressure transducer protects against coil freezing and low refrigerant pressure.

## Hybrid Designs Deliver Maximum Energy Efficiency

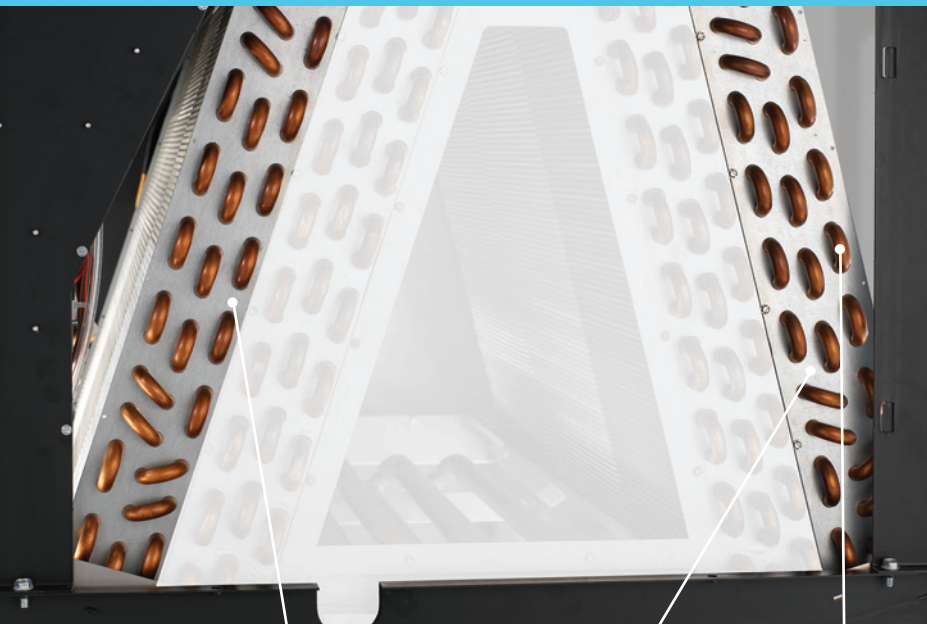

Optional 70/30 Cu/Ni free-cooling coil must be specified to prevent tube corrosion when used with a cooling tower loop or other open water system.

Provides redundancy and energy savings for increased ROI.

Optional econo-coil rests on an A-frame coil to minimize air pressure drop and increase efficiency.

Dual Cooling coil increases availability by using building chilled water as primary, compressor as back-up.

**For even greater efficiency and reduced operating costs, Liebert offers energy saving alternatives such as our GLYCOOL and Dual Cool options. Used where the climate permits, a conventional air or water cooled direct expansion system adds a second cooling coil which utilizes a building chiller supply to reduce compressor operation.**

### **GLYCOOL™ System**

The Liebert GLYCOOL freecooling system incorporates a conventional glycol cooled unit along with the addition of a second cooling coil, control valves and a comparative temperature monitor. This allows the system to take advantage of cooler outdoor temperatures to reduce or eliminate compressor runtime. During colder months, the glycol solution returning from the outdoor drycooler is routed to the second coil by a pre-piped modulating three-way valve. Located upstream of the evaporator coil, the second coil becomes the primary source of cooling for the room. This coil is sufficiently sized to offer the identical cooling capacity as is obtained during the refrigeration cycle of both compressors.

### **Dual Cool**

Utilizing this option, a conventional air cooled Liebert DS is converted to a dual source cooling system by the addition of a second coil that utilizes a central building chiller supply. Using a modulating control valve and a comparative temperature sensor, the unit can function either as a chilled water system, as a compressorized system—or a combination of both.

During times when the chiller supply is available, compressor operation is eliminated, reducing energy costs. Switchover between the two cooling modes is performed automatically by a microprocessor control and temperature sensor. In addition to energy efficiency, this option can provide increased redundancy and flexibility to the environmental control system.

## Controlling The Critical Environment

**A key to the ability of a quality Mission Critical Cooling system to control conditions within the critical space is its high “sensible heat ratio.”**

Unlike people, computers generate dry or “sensible” heat, but not humidity. With a large percentage of their total capacity devoted to the removal of moisture, comfort systems can lower room humidity far below acceptable standards for electronic equipment—and they have no provisions for adding moisture.

To correct this situation, precision air conditioning systems typically have a high ratio of sensible-to-total cooling capacity to remove heat from the air. This capability is provided through the use of integrated humidification systems to provide the necessary level of moisture control, higher air supply capacity and larger coil size.

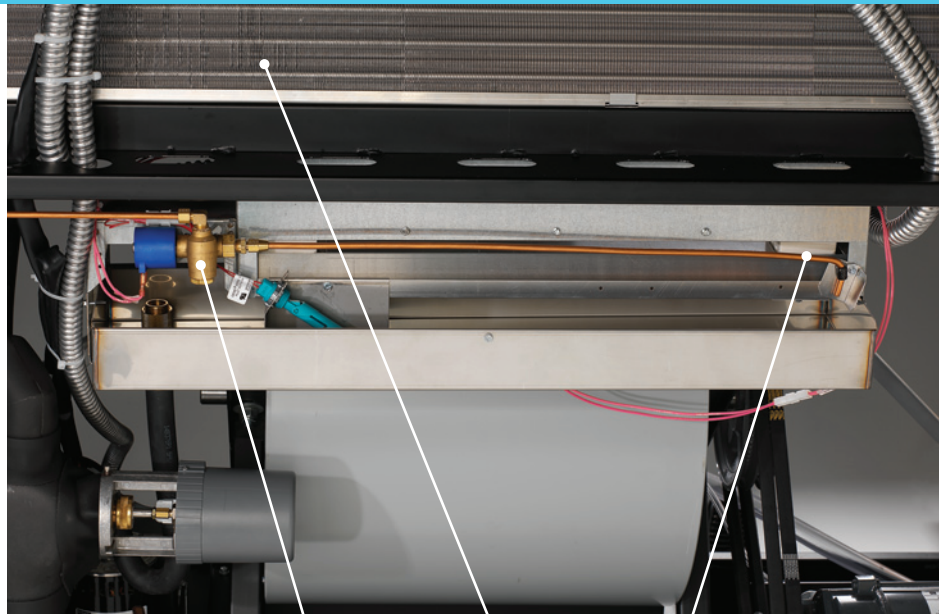

### Standard Infrared Humidifier

Humidifier make-up valve controls flow of water to the humidifier pan.

Pure water vapor provides most effective humidification.

Does not depend on water quality. High-intensity quartz lamps shine on water creating instantaneous moisture using almost any water quality.

### Humidity Control

Maintaining the correct humidity level in the room is just as important as maintaining proper temperature. Inadequate humidity control can cause static electricity if it's too dry—or condensation that can corrode circuitry if the air is too moist. The Liebert DS utilizes an integrated humidification system to provide the necessary level of moisture control.

#### Standard Infrared Humidifier

- **Instant Humidification**—on when needed, off when not needed.

#### Optional Steam Generating Canister Humidifier

- **Utilizes replaceable bottle**—requires a specific water quality level for optimum operation.
- **Utilizes a drain and refill cycle**—to maintain a current setpoint.

### Dehumidification Control

The compressors operate at full capacity during dehumidification. The precision control of the Liebert DS saves energy by tightly regulating compressor operation and avoiding over-dehumidification that causes the humidifier to come on when not needed.

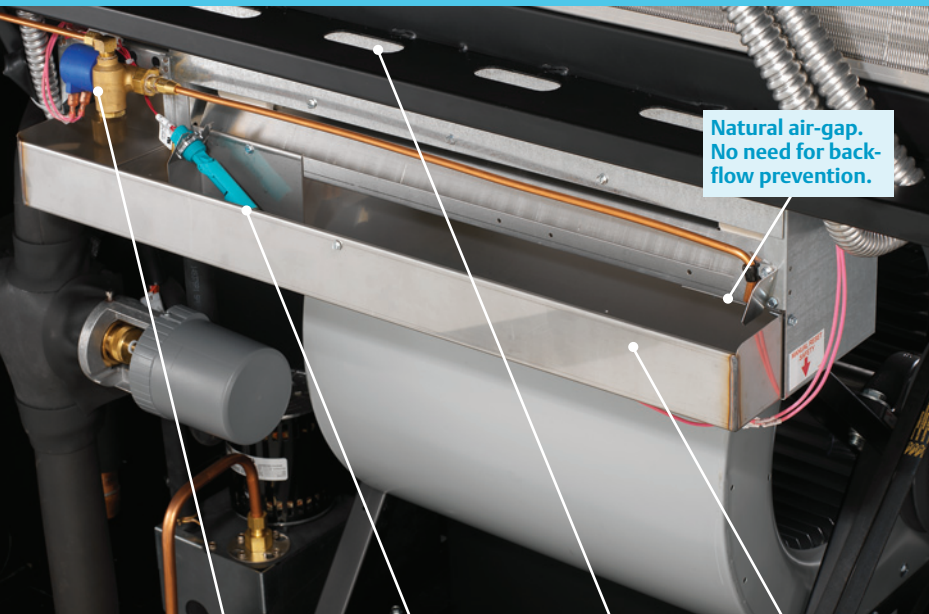

Natural air-gap.  
No need for back-flow prevention.

Autoflush system reduces build-up of mineral deposits and impurities in the water pan.

High water float switch shuts down humidifier upon high water.

Bypass air slots ensure that moisture can be introduced into air stream.

Cleanable stainless steel humidifier pan. Removable from front.

### Reheat Function

The reheat function of the Liebert DS is primarily used to keep the temperature from going too low during the dehumidification cycle.

### Standard Reheat

- **Three-stage electric reheat**—low watt-density, 304 stainless-steel fin-tubular reheat, location maximizes airflow to maximize element life and improve reliability.



### Filtration System

The Liebert DS features integral air filtration to protect against airborne contaminants within the critical environment. Without proper air filtration, even small amounts of dust and other particles can damage storage media and charged electronic components.

- **High-efficiency air-filtration**—removes damaging particles from air.
- **Standard filter**—4" deep, Merv 8. (45% ASHRAE 52.1).
- **Optional high-efficiency filter**—4" deep, Merv 11 (60-65% ASHRAE 52.1)
- **Optional 2" Merv 7 pre-filter** with 2" Merv 11 filter.
- **V bank filter arrangement**—reduces air pressure drop, top filter access.

Minimum Efficiency Reporting Value (MERV), adopted by ASHRAE in its 52.2 standard.

### Reheat Options

- **SCR electric reheat**—For specialized applications requiring tight temperature control. Multiple pulses of reheat vs. three equal stages provide smooth temperature adjustment.
- **Optional hot water reheat**—Uses existing building hot water, saving energy.
- **Reheat/humidifier lockout**—Reduces power requirements during emergency power operation.



# A Choice Of Compressors Offers Higher Efficiency, Adaptability And Reliable Operation

## It Starts With Reliable Scroll Compressor Technology

The scroll compressor design provides high efficiency, low sound levels and excellent durability. The Liebert DS precision cooling system is available with either:

- A standard fixed-capacity scroll compressor.
- An optional Digital Scroll compressor with energy saving, variable capacity operation.

## The Standard Scroll Compressor: Rugged, Quiet, Efficient

The standard scroll compressor offers efficient, reliable performance with a robust design that contains only a few moving parts. Quiet operation is accomplished through a continual, smooth compression process. Discharge gas and vibration are kept at a low level.

## The Digital Scroll Compressor: A New Standard For Performance and Reliability

The exclusive digital scroll compressor option on the Liebert DS utilizes the latest control technology to deliver precise operation and significantly higher energy efficiency. In addition to the advantages of the dependable scroll design, Digital Scroll technology provides infinitely variable capacity modulation that enables the output to precisely match the changing cooling demands of the room. This approach is as much as 30 percent more efficient than traditional hot-gas bypass. Benefits include:

- **Greater energy savings**—variable capacity system allows maximum load tracking for higher efficiency.
- **Improved reliability**—by reducing compressor cycling and component wear.
- **Improved performance**—the compressor can easily adapt to changing load conditions, providing precise temperature control.

## Cumulative Compressor Cycles As Load Grows From 50% To 100%

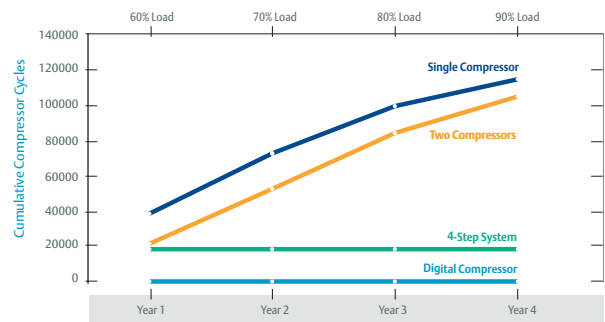

Increasing compressor cycling takes a toll on compressor life. Liebert Four-Step Semi-Hermetic compressors and Digital Scroll compressors automatically adjust to yearly increases in heat load, providing significantly greater component life than other compressor technologies.

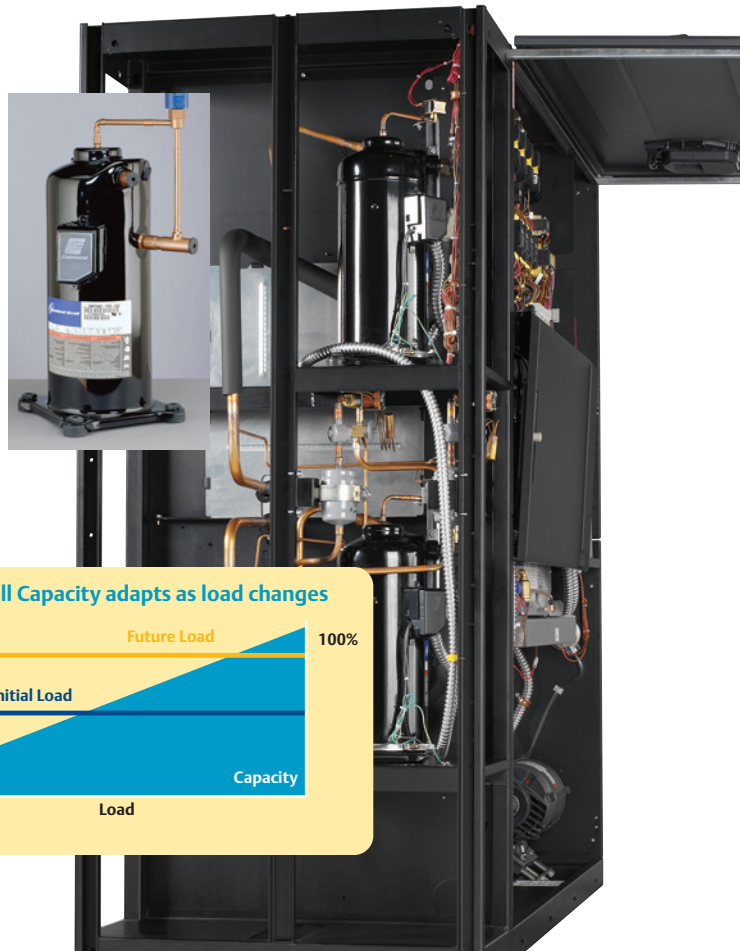

## Digital Scroll Capacity Control Diagram

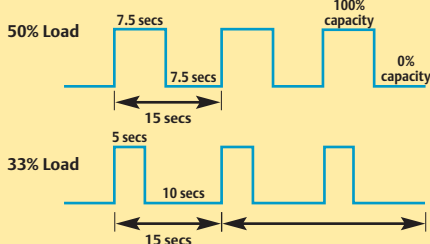

## Digital Scroll Capacity adapts as load changes

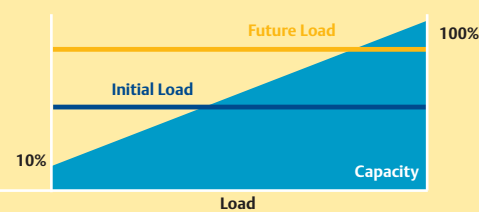

## Four-Step Semi-Hermetic Compressors: Proven Performance

The Liebert DS Four-Step system achieves high levels of energy efficiency through the integration of two high-efficiency semi-hermetic compressors with capacity control valves, an advanced microprocessor control system and a computer-optimized cooling coil.

The Four-Step system reduces compressor cooling capacity and energy consumption during periods of low room load conditions. As a result, four distinct stages of cooling are activated to more closely respond to changing room conditions. Reliability is enhanced by fewer and less stressful compressor starts for reduced wear.

### Energy Savings

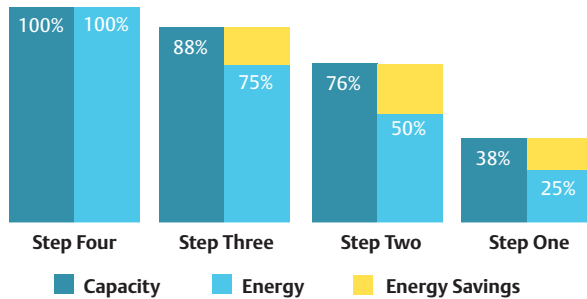

### 4-Step Compressor Operation Improves Energy Efficiency Ratio

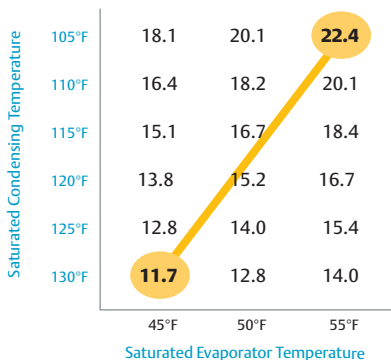

## New Refrigerants To Meet Government Regulations

Without the ability to utilize newer environmentally-friendly refrigerants, your cooling equipment could become obsolete and “out of compliance.” The Montreal Protocol and EPA Clean Air Act require cooling equipment manufacturers to switch to environmentally-friendly refrigerants by 2010.

- **R-407C** is Liebert’s choice for optional environmentally-friendly refrigerant to meet future environmental standards. This is the best fit for Liebert applications, with near drop-in replacement.
- **R-22** is the standard refrigerant offered in the Liebert DS.
- **Field conversion** from R-22 to R-407C refrigerant is most practical for scroll compressors. Some R-22 systems use mineral oil, while R-407C refrigerants utilize POE (polyolester) oil. Therefore, a complete system clean-out may be required.

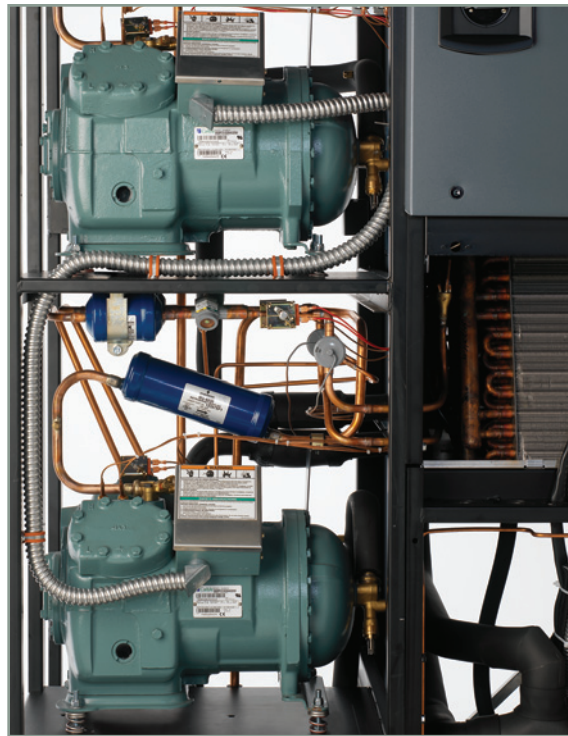

Semi-Hermetic Compressors

# Liebert iCOM™



Removable display makes troubleshooting servicing easier.



Parts list available on control for easier maintenance.



Monitors all key system functions and reports to alarm, if needed.



On-board Unit Diary provides a maintenance history to any authorized user.



Small Graphic Display

The standard Small Graphic Display features a 128x64 dot matrix backlit screen. Advanced monitoring can be achieved with the addition of the Optional Wall Mounted Display.

The Liebert iCOM control system featured on the Liebert DS brings high-level supervision to multiple units allowing them to work together as a single system to optimize room performance. The Liebert iCOM control system offers a variety of advantages.

## Intelligent Communications And Monitoring

- Saves Energy using Predictive Humidity Control.
- Built-in Lead/Lag Functions for enhanced system reliability.
- Wellness Calculation alerts service personnel before problems occur.
- Unit to Unit Communications allows Lead/Lag and optional teamwork settings for maximum flexibility of control.

The Optional Wall Mounted Large Graphic Display provides centralized monitoring and control of connected Liebert DS units.



The optional vNSA with iCOM combines a Wall Mounted Large Graphic Display along with a network switch to facilitate U2U wiring in one convenient cabinet.





Large Graphic Display

Maintenance/Wellness Set-up

### Additional Views Available with Large Graphic Displays

- **System View**—Allows you to see the average operation of the “system” or all units that are working together in Unit to Unit (U2U) Communication mode for Teamwork or Lead/Lag from a centralized location.
- **Spare Parts List**—Critical spare part numbers are saved in unit memory and may be displayed on the Large Graphic Display, speeding identification of parts.
- **Unit Diary**—Free field area within the unit memory where unit maintenance shares history with any authorized users or logged-in service contacts, including record of what others have done.

SPARES		
DESCRIPTION	QTY	PART #
MAIN FAN MOTOR	1	B-025A
FAN BELT	2	B-0600
AIR FILTER	4	A-0010
COMPRESSOR	2	1C13810P2
HEATER ELEM	3	149367P19
HUMIDIFIER LAMP	4	H-0020

Spare Parts

UNIT DIARY		
DATE	DESCRIPTION	USER
09.13.2004	No problem found	Fred
08.23.2004	Set 77 °F as setpoint, convinced customer that 68 °F is far too low	Jim
08.22.2004	Filters changed, were dirty	John
08.16.2004	Routine Maintenance performed.	Jack

Unit Diary

STANDBY SETTINGS		
PARAMETER	VALUE	UNIT
S201 PASSWORD (LEVEL 0)	????	
S202 NUMBER OF STANDBY UNITS	2	
S203 ROTATION FREQUENCY	DAILY	
S204 ROTATE AT (HOUR)	10	
S205 ROTATE AT (MINUTE)	30	
S206 PERFORM ONE ROTATION	NO	
S207 CASCADE UNITS	YES	

Standby Settings (Lead/Lag Set-up)

The optional Large Graphic Display features a 320x240 dot matrix backlight screen with helpful system and maintenance views.

### U2U Configuration 2

Liebert DS units with Small Graphic Display may be centrally monitored and controlled with the Optional Wall Mounted Display.

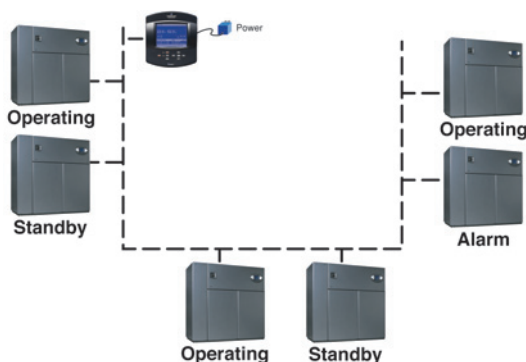

### Teamwork: Mode 2

Units work together to provide precision cooling in rooms with unbalanced loads.

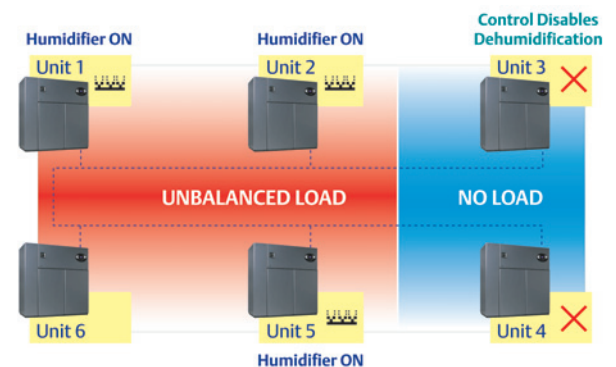

## *Paradenser™ Cleanable Condenser Provides Liebert DS With Longer Service Life*

The Liebert DS mission-critical cooling system offers the new Paradenser™ condenser for use in water/glycol systems. This patented component utilizes a counter-flow design and features a shell and tube type construction.

- **Fully cleanable**—eliminates costly condenser failures due to plugging and providing a longer service life. This reduces fouling and scaling which can degrade heat rejection performance and result in cooling system shutdown. Large water passages prevent plugging and allow for conventional tube cleaning methods.
- **Sturdy, corrosion-resistant materials**—Steel shell, copper tubes, and nickel-plated plug are durable, non-corrosive and easy to clean.
- **Shell side of the condenser acts as a receiver**—holds refrigerant charge during pumpdown.
- **Works equally well with either R-407C or R-22 refrigerants**—high velocity refrigerant shell eliminates need to upgrade condenser when changing to alternate refrigerant. Counterflow design and high refrigerant velocities significantly maintain performance when using R-407C refrigerant.
- **Utilizes no gaskets**—offers further reliability by preventing leaks.



Fully cleanable Paradenser tubes are located for convenient maintenance.

# Liebert Heat Rejection Systems—Flexible Configurations To Meet Application Requirements

## Liebert Condensers & Drycoolers

Liebert manufactures its own high-efficiency air cooled condensers and drycoolers that are precisely matched to the heat rejection requirements of our precision air conditioning systems. Constructed with an aluminum cabinet and a copper-tube aluminum-fin coil, these exceptionally dependable units are corrosion resistant and designed to operate for prolonged periods of exposure to the worst weather conditions. Liebert condensers and drycoolers are fully factory wired and tested for easy installation.



- **Wide range of heat rejection solutions**—vertical or horizontal airflows, indoor or outdoor models, freestanding or ducted configurations.
- **Standard units**—Sized for maximum outdoor ambient temperatures of 85 °F (29.4°C) to 105°F (40.6°C).
- **Liebert VFD Control Condenser**—Features a variable frequency drive (VFD) and an inverter duty fan motor with ceramic bearings. The VFD control integrates pressure variations from either compressor operation, including digital scroll compressors, using pressure transducers and modulates the condenser fan motor speed to hold condensing temperatures constant. This system allows for operation at ambient temperatures as low as -20°F (-28.9°C).
- **Fan Speed Control Condenser**—A fan-speed control varies the variable speed fan motor based on compressor head pressure to maintain constant condensing temperatures. This system allows for operation at ambient temperatures as low as -20°F (-28.9°C).
- **Drycoolers, Pumps, Tanks and Controls**—Complete heat rejection solutions for glycol-cooled and GLYCOOL units consist of drycoolers, glycol pumps, expansion tanks and integral or separate pump electrical control boxes.
- **Quiet-Line™ Condenser/Drycooler**—Operate with the lowest noise level of any heat rejection available, offering levels of less than 57 dBA.
- **Indoor Piggyback Condenser/Drycooler**—Indoor condensers/drycoolers designed to provide heat rejection by ducting air from outside the building, such as high-rise buildings.
- **Outdoor Centrifugal Condenser/Drycooler**—Centrifugal drycoolers suitable for outdoor or indoor mounting, providing heat rejection for unique applications requiring ducted airflow.
- **High Ambient Condensers**—Utilize increased coil surfaces for operation in outdoor climates up to 120 °F (48.9°C).

# No Other Precision Cooling System Offers This Much Flexibility

The Liebert DS Has A Solution To Meet Your Critical Needs

Long recognized as the standard in environmental control systems for data center operations, the Liebert DS is built to the most demanding specifications in the industry with proven components and design. Liebert DS features compressorized direct expansion operation in air cooled, water cooled and glycol cooled configurations, as well as GLYCOOL™ free-cooling models and chilled water systems.

## Water Cooled

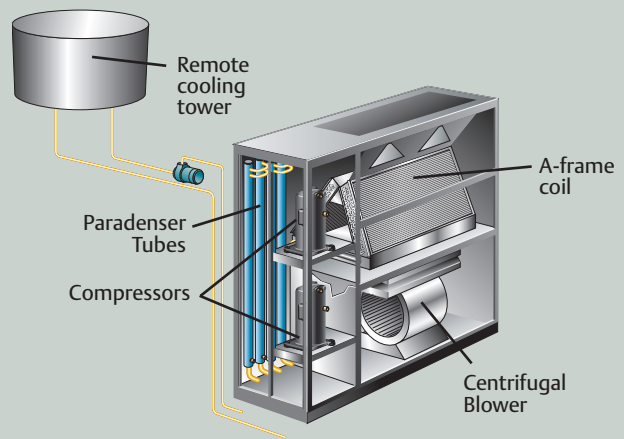

## GLYCOOL™ System with free-cooling cool

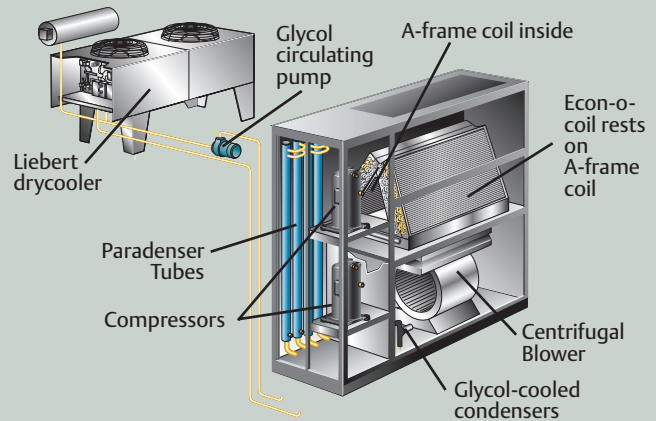



### Air Cooled

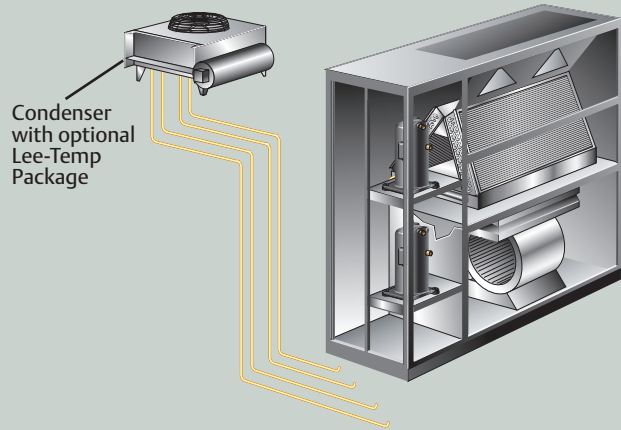

### Glycol Cooled

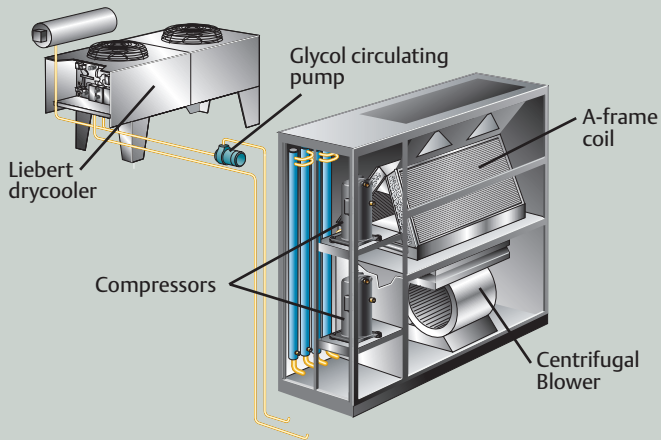

### Piggyback Heat Rejection Configurations

Air-cooled or Glycol-cooled configurations available

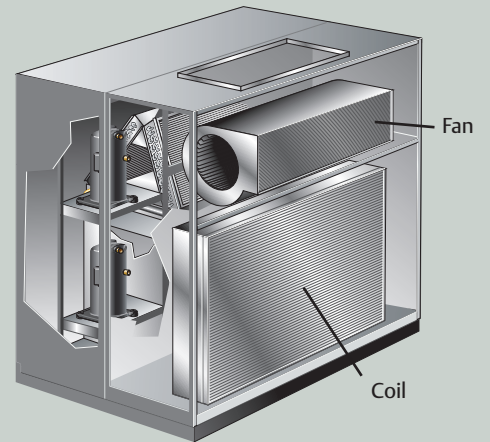

## Stand-Alone Monitoring And Leak Detection Solutions

**Autonomous microprocessor controlled modules are available to provide supervision, control and remote notification of Liebert precision cooling equipment. These stand-alone devices include:**

### Liebert Universal Monitor

The Liebert Universal Monitor is an all-purpose, easy-to-use microprocessor-based monitoring panel with connections for up to 8 digital inputs, 8 digital outputs and 4 analog inputs. Designed to bring critical monitoring information directly to your facility or offsite location, the unit includes an on-board modem to provide remote monitoring while minimizing configuration and installation requirements. It features a built-in LCD user interface, making the panel self-contained and accessible without additional hardware and software.

### Contact Closure Alarm Panels

The Liebert RCM series of contact closure alarm panels provides customized alarm indication at a single location for any dry contact input from environmental, power and UPS systems, including Liebert units. These remote systems continuously monitor your most critical support equipment and instantly alert you to alarm conditions. Three different system configurations are available for monitoring up to eight points with communications and pager interface plus eight digital outputs.



Liebert Universal Monitor

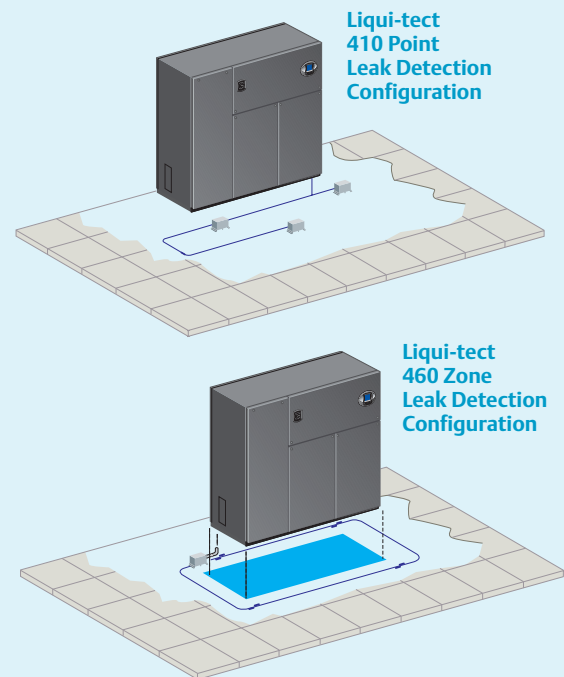

Liqui-tect  
410 Point  
Leak Detection  
Configuration

Liqui-tect  
460 Zone  
Leak Detection  
Configuration

### Liebert Leak Detection Modules

Liebert Liqui-tect® leak detection systems provide quick sensing and accurate reporting of leaks below the floor or above the ceiling in critical facilities. These reliable systems provide immediate warning and precise location, allowing you to find and correct a leak before moisture can damage computers, wiring connections or other sensitive electronics.

### Temperature and Humidity Recorder

A seven-day temperature and humidity recorder permits close examination of computer room environment condition and can be used as a permanent record of the environmental control system's operation efficiency.

# Maximizing Your Investment Through Adaptive Monitoring

## Distributed Management with Liebert IntelliSlot Interface Cards

For enhanced remote communications and control of your Liebert units, the Liebert IntelliSlot Web Card will deliver SNMP and web-management communications capabilities.

### Monitoring and control through your existing Network with no additional software required.

Each Liebert system equipped with an Liebert IntelliSlot Web Card takes full advantage of your Ethernet network, allowing remote monitoring from your computer desktop, network operations center or wherever network access is permitted, without the need for front-end software.

The Liebert IntelliSlot Web Card supports 10 and 100 MBit Ethernet network transmissions speeds, which will be auto-detected upon connection to the network. Plus, these cards support in-the-field firmware updates.



Liebert IntelliSlot Web

## Centralized Management with Liebert Nform Software

As business grows, your critical equipment infrastructure will expand, thus the need for centralized management of this equipment will be key to your business success. Connecting to equipment in the distributed critical space is only part of the monitoring challenge.

### Liebert Nform leverages the network connectivity capabilities of your Liebert equipment to provide a centralized monitoring view of your distributed equipment.

Utilizing the SNMP and Web technologies built into each of the Liebert IntelliSlot communication cards, Nform will centrally manage alarm notifications to provide you with an easy interface to access critical status information. Liebert Nform puts critical systems information at the fingertips of support personnel—wherever they are—increasing responsiveness to alarm-event conditions, thus allowing IT organizations to maximize their system availability.

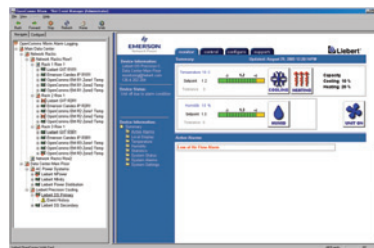

Liebert Nform

## Enterprise Management with Liebert SiteScan® Web Software

For customers who require extensive management of critical system equipment that may span multiple locations in an ever-moving global enterprise, Liebert SiteScan Web will centrally manage your critical equipment and give you the power to move beyond the event-responsive service paradigm.

### Liebert SiteScan Web does it all—

- Real-Time Monitoring and Control
- Event Management and Reporting
- Data Analysis and Trending
- Building Management Integration

Liebert SiteScan Web is a comprehensive critical systems management solution dedicated to ensuring reliability through graphics, event management and data extrapolation. The standard Web interface allows users easy access from anywhere at anytime.

- Single- and multi-site applications.
- Event management and unit control.
- Trend and historical data captures and reporting.
- Full ASHRAE BACnet compatibility.
- Java based.
- Windows 2000, XP and 2003 compatible.

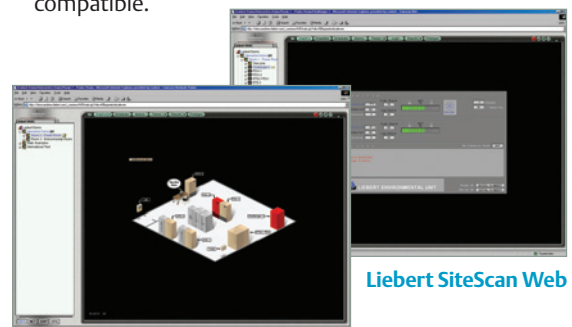

Liebert SiteScan Web

# Ensuring The High Availability Of Mission-Critical Data And Applications.

**Emerson Network Power, the global leader in enabling business-critical continuity, ensures network resiliency and adaptability through a family of technologies—including Liebert power and cooling technologies—that protect and support business-critical systems. Liebert solutions employ an adaptive architecture that responds to changes in criticality, density and capacity. Enterprises benefit from greater IT system availability, operational flexibility, and reduced capital equipment and operating costs.**

## **Liebert Corporation**

1050 Dearborn Drive  
P.O. Box 29186  
Columbus, Ohio 43229  
800 877 9222 Phone (U.S. & Canada Only)  
614 888 0246 Phone (Outside U.S.)  
614 841 6022 FAX

Via Leonardo Da Vinci 8  
Zona Industriale Tognana  
35028 Piove Di Sacco (PD)  
Italy  
39 049 9719 111 Phone  
39 049 5841 257 FAX

Emerson Network Power Asia Pacific  
7/F., Dah Sing Financial Centre  
108 Gloucester Rd, Wanchai  
Hong Kong  
852 25722201 Phone  
852 28029250 FAX

## **liebert.com**

### **24 x 7 Tech Support**

800 222 5877 Phone  
614 841 6755 (outside U.S.)

While every precaution has been taken to ensure accuracy and completeness in this literature, Liebert Corporation assumes no responsibility, and disclaims all liability for damages resulting from use of this information or for any errors or omissions.

© 2006 Liebert Corporation. All rights reserved throughout the world. Specifications subject to change without notice.

All names referred to are trademarks or registered trademarks of their respective owners.

® Liebert and the Liebert logo are registered trademarks of the Liebert Corporation.

SL-18810 (R11/06) Printed in USA

## **Emerson Network Power.**

The global leader in enabling Business-Critical Continuity™.

- AC Power
- Embedded Computing
- Outside Plant
- Racks & Integrated Cabinets
- Connectivity
- Embedded Power
- Power Switching & Controls
- Services
- DC Power
- Monitoring
- Precision Cooling
- Surge Protection

Business-Critical Continuity, Emerson Network Power and the Emerson Network Power logo are trademarks and service marks of Emerson Electric Co.  
©2006 Emerson Electric Co.