



Industrial Batteries – Network Power
Sprinter P
Reliable capacities for increased security.

Specifications

Specifications









- The extremely powerful, compact AGM batteries of the Sprinter P series are an ideal energy source for uninterrupted power supply and are particularly good in UPS applications
- Excellent high current performance in addition to a long service life
- Maintenance-free (no topping up) during the whole service life
- Power (15 minutes) from 600 – 2130 watt
- 10 years design life at 20 °C ambient temperature (80% remaining capacity)
- EUROBAT Classification: High Performance
- Case material acc. to UL 94-HB
- Designed in accordance with IEC 60896-21/-22
- Grid plate construction consisting of a lead calcium alloy
- Very low gassing due to internal gas recombination (99% efficient)
- Low self discharge rate
- Very short recharge time
- Trouble-free transportation of operational blocks, no restrictions for rail, road, sea and air transportation (IATA, DGR clause A67)
- Completely recyclable



Applications

The Sprinter P series is a very versatile and well classified product range due to its unique high current discharge characteristics, making this battery ideally suited for high current discharge performance. UPS applications and other security systems will all benefit from the Sprinter P series.



 Design life in years: 10	 Nominal capacity 24.0 – 178 Ah	 Block battery	 Grid plate
 Recyclable	 Valve regulated lead-acid batteries	 Maintenance-free (no topping-up)	 Special high current performance

Type	Part number	Nom. voltage V	Power 15 min 1.60 Vpc 25 °C W/block	Nominal capacity C ₁₀ 1.80 Vpc 25 °C Ah	Nominal capacity C ₂₀ 1.75 Vpc 20 °C Ah	Length (l) max. mm	Width (b/w) max. mm	Height (h1) max. mm	Weight approx. kg	Internal resistance m0hm	Short circuit current A	Terminal
P6V1700	NAPW061700HP0MC	6	1700	122	-	273	167	191	25.0	2.30	2930	M-M8
P6V2030	NAPW062030HP0MA	6	2030	178	-	360	172	227	32.5	1.70	3770	M-M8
P12V600	NAPW120600HP0MA	12	600	24.0	26.0	169	128	175	9.50	17.0	760	M-M6
P12V875	NAPW120875HP0MC	12	875	41.0	40.0	200	169	176	14.5	12.9	1000	M-M6
P12V1220	NAPW121220HP0MC	12	1220	51.0	-	233	169	191	19.5	9.90	1290	M-M6
P12V1575	NAPW121575HP0MC	12	1575	61.0	65.0	273	167	191	24.0	8.10	1580	M-M6
P12V2130	NAPW122130HP0MA	12	2130	86.0	-	360	173	227	33.0	6.00	2180	M-M8

P12V600, P12V875 und P12V1575 with VdS authorization

Container, terminal and torque

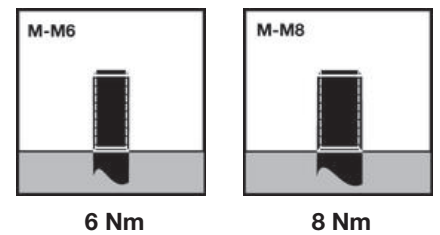

Container: UL 94-HB = Polypropylen (PP)

P6V1700

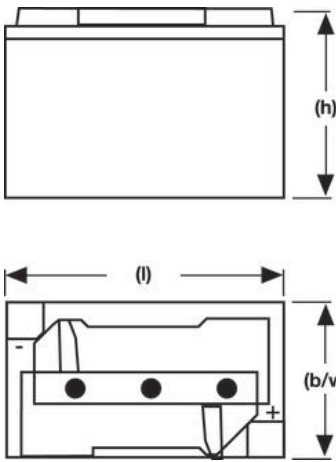

P6V2030

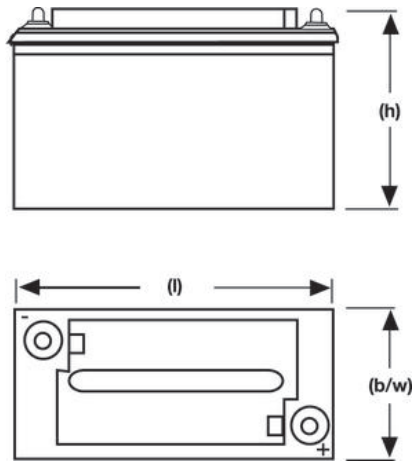

P12V600

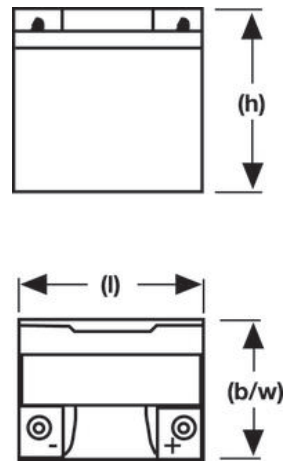

P12V875

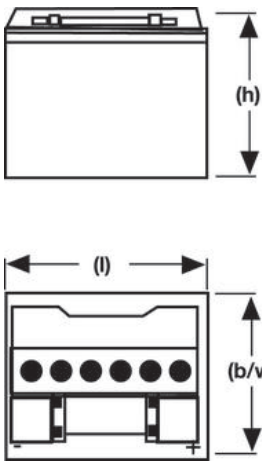

P12V1220

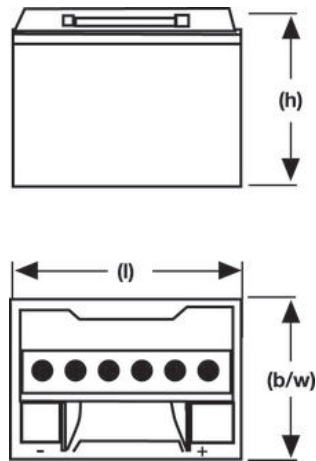

P12V1575

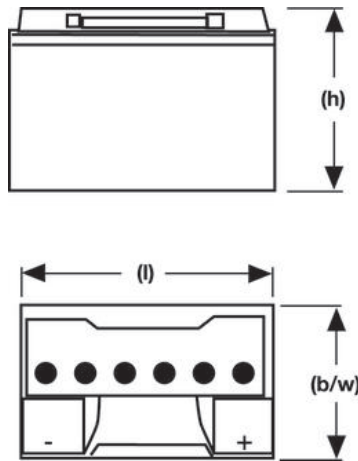

P12V2130

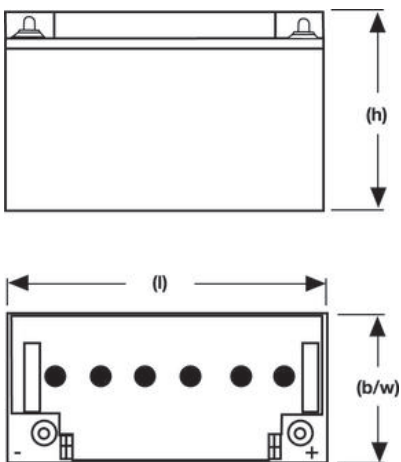

Not to scale!

1.95 Vpc – Discharge in A at 25 °C															
Type	Part number	3 min	5 min	10 min	15 min	20 min	30 min	45 min	1 h	2 h	3 h	5 h	8 h	10 h	20 h
P6V1700	NAPW061700HPOMC	179	176	165	145	130	103	77.4	62.9	33.8	24.1	15.5	10.6	9.00	4.80
P6V2030	NAPW062030HPOMA	226	224	204	179	161	132	101	83.2	47.9	35.5	23.3	15.8	13.3	7.00
P12V600	NAPW120600HPOMA	46.0	43.0	36.0	29.0	25.0	19.0	14.2	11.4	6.60	4.80	3.20	2.20	1.90	1.00
P12V875	NAPW120875HPOMC	61.0	58.0	50.0	42.0	36.0	28.0	22.3	18.3	11.2	8.10	5.20	3.60	3.00	1.60
P12V1220	NAPW121220HPOMC	94.0	87.0	72.0	60.0	51.0	39.0	28.9	23.3	13.7	9.60	6.60	4.60	3.90	2.00
P12V1575	NAPW121575HPOMC	109	104	90.0	76.0	66.0	50.0	37.6	29.4	17.1	12.2	8.00	5.40	4.60	2.40
P12V2130	NAPW122130HPOMA	158	149	126	103	88.0	69.0	50.8	41.0	23.2	17.1	11.3	7.60	6.60	3.50

1.90 Vpc – Discharge in A at 25 °C															
Type	Part number	3 min	5 min	10 min	15 min	20 min	30 min	45 min	1 h	2 h	3 h	5 h	8 h	10 h	20 h
P6V1700	NAPW061700HPOMC	286	267	223	187	162	125	94.0	76.1	41.4	29.2	19.1	12.7	10.9	5.80
P6V2030	NAPW062030HPOMA	345	325	272	227	198	154	120	97.4	58.4	42.6	28.4	18.9	16.0	8.40
P12V600	NAPW120600HPOMA	70.0	62.0	47.0	37.0	30.0	22.0	17.0	13.4	8.00	5.90	4.00	2.60	2.10	1.10
P12V875	NAPW120875HPOMC	96.0	85.0	65.0	52.0	44.0	35.0	26.0	21.1	12.8	9.40	6.30	4.30	3.70	1.90
P12V1220	NAPW121220HPOMC	137	121	93.0	74.0	62.0	46.0	34.0	27.4	16.7	12.2	8.20	5.40	4.60	2.40
P12V1575	NAPW121575HPOMC	163	150	118	95.0	80.0	60.0	44.0	35.3	20.4	14.4	9.90	6.50	5.50	2.90
P12V2130	NAPW122130HPOMA	248	220	164	128	107	81.0	60.0	48.3	28.5	20.7	13.8	9.10	7.60	4.10

1.85 Vpc – Discharge in A at 25 °C															
Type	Part number	3 min	5 min	10 min	15 min	20 min	30 min	45 min	1 h	2 h	3 h	5 h	8 h	10 h	20 h
P6V1700	NAPW061700HPOMC	388	349	279	227	192	145	107	83.4	46.3	32.5	21.3	13.8	11.6	6.20
P6V2030	NAPW062030HPOMA	462	422	339	275	232	176	133	108	63.9	48.0	31.7	20.6	17.0	8.90
P12V600	NAPW120600HPOMA	92.0	76.0	55.0	43.0	35.0	25.0	19.0	15.2	9.20	6.70	4.40	2.80	2.30	1.20
P12V875	NAPW120875HPOMC	128	109	79.0	62.0	52.0	40.0	29.0	24.0	14.4	10.6	7.00	4.70	3.90	2.00
P12V1220	NAPW121220HPOMC	178	151	110	86.0	70.0	52.0	38.0	30.5	18.8	13.7	8.90	5.80	4.90	2.60
P12V1575	NAPW121575HPOMC	220	189	139	110	91.0	67.0	49.0	39.0	22.2	15.8	10.7	7.00	5.90	3.10
P12V2130	NAPW122130HPOMA	328	273	195	152	124	91.0	67.0	53.5	32.0	23.3	14.8	9.80	8.20	4.40

1.80 Vpc – Discharge in A at 25 °C															
Type	Part number	3 min	5 min	10 min	15 min	20 min	30 min	45 min	1 h	2 h	3 h	5 h	8 h	10 h	20 h
P6V1700	NAPW061700HPOMC	479	421	319	254	209	155	114	89.4	49.3	34.3	22.8	14.7	12.2	6.50
P6V2030	NAPW062030HPOMA	561	497	386	310	255	192	141	115	69.3	52.1	33.3	21.6	17.8	9.40
P12V600	NAPW120600HPOMA	107	87.0	61.0	46.0	38.0	27.0	20.0	16.2	9.70	7.10	4.60	2.90	2.40	1.30
P12V875	NAPW120875HPOMC	153	127	89.0	68.0	56.0	42.0	31.0	25.4	15.4	11.4	7.50	4.90	4.10	2.10
P12V1220	NAPW121220HPOMC	203	170	121	94.0	76.0	56.0	41.0	32.5	19.6	14.4	9.30	6.20	5.10	2.70
P12V1575	NAPW121575HPOMC	263	220	156	120	99.0	72.0	53.0	42.0	23.8	17.2	11.2	7.40	6.10	3.20
P12V2130	NAPW122130HPOMA	380	313	215	164	134	98.0	71.0	56.3	33.5	24.4	15.6	10.4	8.60	4.60

1.75 Vpc – Discharge in A at 25 °C															
Type	Part number	3 min	5 min	10 min	15 min	20 min	30 min	45 min	1 h	2 h	3 h	5 h	8 h	10 h	20 h
P6V1700	NAPW061700HPOMC	562	483	353	275	223	163	117	92.4	51.4	35.3	23.5	15.2	12.5	6.60
P6V2030	NAPW062030HPOMA	647	563	424	334	272	199	146	118	71.1	53.6	34.1	22.1	18.3	9.60
P12V600	NAPW120600HPOMA	118	95.0	65.0	49.0	40.0	28.0	20.8	17.1	9.90	7.30	4.70	3.00	2.50	1.30
P12V875	NAPW120875HPOMC	168	138	95.0	72.0	59.0	44.0	33.0	26.6	16.2	11.8	7.70	5.10	4.30	2.20
P12V1220	NAPW121220HPOMC	228	187	130	100	81.0	59.0	42.1	34.0	20.3	14.9	9.60	6.30	5.20	2.80
P12V1575	NAPW121575HPOMC	299	244	169	128	105	76.0	54.8	43.8	25.0	18.0	11.5	7.60	6.20	3.30
P12V2130	NAPW122130HPOMA	419	338	231	177	142	104	73.6	58.9	34.6	25.4	16.3	10.7	8.80	4.70

1.70 Vpc – Discharge in A at 25 °C

Type	Part number	3 min	5 min	10 min	15 min	20 min	30 min	45 min	1 h	2 h	3 h	5 h	8 h	10 h	20 h
P6V1700	NAPW061700HP0MC	629	529	377	291	234	168	120	94.5	53.3	36.5	24.2	15.4	12.6	6.70
P6V2030	NAPW062030HP0MA	713	616	453	350	282	206	151	120	72.1	54.4	34.7	22.4	18.6	9.80
P12V600	NAPW120600HP0MA	129	103	69.0	52.0	42.0	29.4	21.8	17.6	10.3	7.40	4.80	3.10	2.60	1.40
P12V875	NAPW120875HP0MC	184	148	99.0	75.0	61.0	45.2	34.0	27.6	16.8	12.2	7.90	5.20	4.40	2.30
P12V1220	NAPW121220HP0MC	247	202	138	105	84.0	60.9	43.6	35.0	20.8	15.2	9.80	6.40	5.30	2.80
P12V1575	NAPW121575HP0MC	328	266	180	134	108	78.2	55.8	44.7	25.6	18.5	11.8	7.70	6.30	3.30
P12V2130	NAPW122130HP0MA	456	360	243	183	147	106	75.6	60.9	35.4	26.2	16.8	10.9	9.00	4.80

1.65 Vpc – Discharge in A at 25 °C

Type	Part number	3 min	5 min	10 min	15 min	20 min	30 min	45 min	1 h	2 h	3 h	5 h	8 h	10 h	20 h
P6V1700	NAPW061700HP0MC	676	563	395	299	241	173	123	96.5	54.6	37.8	24.3	15.5	12.6	6.70
P6V2030	NAPW062030HP0MA	771	655	469	360	291	211	153	121	72.6	54.9	34.8	22.5	18.7	9.90
P12V600	NAPW120600HP0MA	136	109	71.0	54.0	43.0	30.5	22.3	18.0	10.4	7.50	4.80	3.10	2.60	1.40
P12V875	NAPW120875HP0MC	198	157	104	77.0	63.0	46.2	35.0	28.4	17.5	12.5	8.00	5.30	4.40	2.30
P12V1220	NAPW121220HP0MC	263	212	142	107	86.0	61.9	44.7	35.7	21.1	15.4	9.90	6.40	5.30	2.80
P12V1575	NAPW121575HP0MC	351	281	185	138	111	80.2	56.8	45.3	26.0	18.8	12.0	7.70	6.40	3.40
P12V2130	NAPW122130HP0MA	485	380	253	189	151	109	77.6	61.6	35.9	26.6	17.0	11.0	9.00	4.80

1.60 Vpc – Discharge in A at 25 °C

Type	Part number	3 min	5 min	10 min	15 min	20 min	30 min	45 min	1 h	2 h	3 h	5 h	8 h	10 h	20 h
P6V1700	NAPW061700HP0MC	698	582	406	308	247	177	126	98.5	55.4	38.4	24.4	15.5	12.6	6.70
P6V2030	NAPW062030HP0MA	801	680	481	369	296	215	155	122	72.9	55.1	34.8	22.5	18.7	9.90
P12V600	NAPW120600HP0MA	143	113	73.0	55.0	44.0	31.0	22.8	18.3	10.5	7.60	4.80	3.10	2.60	1.40
P12V875	NAPW120875HP0MC	209	164	107	79.0	65.0	47.2	36.0	29.2	17.9	12.6	8.00	5.30	4.40	2.30
P12V1220	NAPW121220HP0MC	272	220	145	109	87.0	62.9	45.2	36.0	21.3	15.5	9.90	6.40	5.30	2.80
P12V1575	NAPW121575HP0MC	369	292	190	140	112	81.2	57.9	45.7	26.2	18.9	12.0	7.70	6.40	3.40
P12V2130	NAPW122130HP0MA	510	398	262	194	154	111	79.2	62.1	36.2	26.8	17.0	11.0	9.00	4.80

1.90 Vpc – Discharge in W/block at 25 °C

Type	Part number	3 min	5 min	10 min	15 min	20 min	30 min	45 min	1 h	2 h	3 h	5 h	8 h	10 h
P6V1700	NAPW061700HPOMC	1641	1537	1267	1067	919	711	545	445	246	174	114	76.1	62.9
P6V2030	NAPW062030HPOMA	2008	1881	1573	1329	1151	918	717	590	348	253	169	112	94.4
P12V600	NAPW120600HPOMA	834	725	539	427	356	271	200	162	97.4	71.1	47.7	31.5	26.4
P12V875	NAPW120875HPOMC	1151	1006	762	608	506	397	304	253	153	112	76.1	50.8	43.6
P12V1220	NAPW121220HPOMC	1609	1426	1088	869	724	549	405	325	198	145	93.4	65.0	53.8
P12V1575	NAPW121575HPOMC	1929	1748	1370	1106	935	711	522	417	243	172	117	78.2	65.0
P12V 2130	NAPW122130HPOMA	2964	2578	1907	1517	1270	963	712	583	338	245	166	109	91.4

1.85 Vpc – Discharge in W/block at 25 °C

Type	Part number	3 min	5 min	10 min	15 min	20 min	30 min	45 min	1 h	2 h	3 h	5 h	8 h	10 h
P6V1700	NAPW061700HPOMC	2176	1982	1586	1302	1107	848	632	498	279	193	126	82.2	68.0
P6V2030	NAPW062030HPOMA	2596	2375	1931	1583	1340	1034	791	643	383	285	185	121	101
P12V600	NAPW120600HPOMA	1033	868	627	491	406	300	221	179	108	79.2	51.8	33.5	28.4
P12V875	NAPW120875HPOMC	1441	1225	906	718	597	462	352	284	170	126	84.2	54.8	46.7
P12V1220	NAPW121220HPOMC	1998	1707	1261	995	821	610	446	362	223	163	101	70.0	57.9
P12V1575	NAPW121575HPOMC	2475	2147	1603	1276	1066	790	576	464	264	188	127	84.2	70.0
P12V 2130	NAPW122130HPOMA	3680	3085	2224	1752	1445	1065	771	635	379	277	176	117	98.5

1.80 Vpc – Discharge in W/block at 25 °C

Type	Part number	3 min	5 min	10 min	15 min	20 min	30 min	45 min	1 h	2 h	3 h	5 h	8 h	10 h
P6V1700	NAPW061700HPOMC	2634	2349	1808	1454	1212	906	664	523	290	203	136	88.3	72.6
P6V2030	NAPW062030HPOMA	3083	2807	2185	1773	1477	1118	834	678	408	306	194	126	105
P12V600	NAPW120600HPOMA	1171	971	689	532	435	320	235	192	113	82.2	54.8	35.5	29.4
P12V875	NAPW120875HPOMC	1688	1418	1013	785	650	492	372	301	183	135	89.3	57.9	48.2
P12V1220	NAPW121220HPOMC	2233	1906	1386	1083	888	648	476	385	232	170	108	74.1	60.4
P12V1575	NAPW121575HPOMC	2881	2438	1763	1385	1147	841	613	495	281	204	134	88.3	72.6
P12V 2130	NAPW122130HPOMA	4173	3444	2440	1897	1558	1137	820	671	396	289	186	122	102

1.75 Vpc – Discharge in W/block at 25 °C

Type	Part number	3 min	5 min	10 min	15 min	20 min	30 min	45 min	1 h	2 h	3 h	5 h	8 h	10 h
P6V1700	NAPW061700HPOMC	3021	2654	1982	1566	1282	950	689	541	300	211	140	89.3	73.6
P6V2030	NAPW062030HPOMA	3473	3092	2385	1900	1562	1161	860	693	416	312	200	128	107
P12V600	NAPW120600HPOMA	1266	1045	732	565	458	336	246	203	116	85.3	55.8	36.5	29.9
P12V875	NAPW120875HPOMC	1823	1523	1074	827	680	513	386	315	192	140	91.4	58.9	49.2
P12V1220	NAPW121220HPOMC	2450	2050	1481	1144	933	682	497	403	238	175	112	75.1	61.4
P12V1575	NAPW121575HPOMC	3207	2684	1908	1479	1204	885	636	515	291	213	138	90.3	73.1
P12V 2130	NAPW122130HPOMA	4511	3690	2593	2009	1637	1199	868	702	406	296	191	124	103

1.70 Vpc – Discharge in W/block at 25 °C

Type	Part number	3 min	5 min	10 min	15 min	20 min	30 min	45 min	1 h	2 h	3 h	5 h	8 h	10 h
P6V1700	NAPW061700HPOMC	3347	2876	2092	1628	1331	977	699	552	311	218	142	90.3	74.1
P6V2030	NAPW062030HPOMA	3790	3325	2512	1963	1614	1192	875	701	419	314	202	130	108
P12V600	NAPW120600HPOMA	1348	1101	762	579	469	343	251	205	118	87.3	56.8	37.0	30.5
P12V875	NAPW120875HPOMC	1948	1605	1109	843	694	525	398	327	197	145	93.4	59.9	50.2
P12V1220	NAPW121220HPOMC	2603	2167	1530	1177	958	700	507	411	242	178	115	76.1	62.4
P12V1575	NAPW121575HPOMC	3469	2866	2002	1524	1241	907	646	520	296	217	140	91.4	74.1
P12V 2130	NAPW122130HPOMA	4798	3895	2695	2060	1677	1220	886	717	412	301	194	126	104

1.65 Vpc – Discharge in W/block at 25 °C

Type	Part number	3 min	5 min	10 min	15 min	20 min	30 min	45 min	1 h	2 h	3 h	5 h	8 h	10 h
P6V1700	NAPW061700HP0MC	3521	3007	2161	1663	1358	994	713	560	316	222	143	91.4	74.1
P6V2030	NAPW062030HP0MA	4011	3483	2576	2005	1636	1206	882	705	421	315	203	130	108
P12V600	NAPW120600HP0MA	1422	1151	780	591	477	347	255	207	119	88.3	56.8	37.0	30.5
P12V875	NAPW120875HP0MC	2069	1677	1133	858	706	533	405	332	202	148	94.4	60.9	50.8
P12V1220	NAPW121220HP0MC	2743	2255	1573	1201	972	710	513	417	245	180	116	76.1	62.4
P12V1575	NAPW121575HP0MC	3650	2982	2053	1553	1262	921	653	525	299	219	141	92.4	75.1
P12V 2130	NAPW122130HP0MA	5054	4060	2756	2102	1698	1240	896	723	417	305	196	127	105

1.60 Vpc – Discharge in W/block at 25 °C

Type	Part number	3 min	5 min	10 min	15 min	20 min	30 min	45 min	1 h	2 h	3 h	5 h	8 h	10 h
P6V1700	NAPW061700HP0MC	3597	3063	2210	1700	1379	1002	720	567	319	224	143	91.4	74.1
P6V2030	NAPW062030HP0MA	4127	3578	2617	2030	1646	1213	887	707	422	316	203	130	108
P12V600	NAPW120600HP0MA	1478	1186	791	600	480	350	258	209	120	88.3	56.8	37.0	30.5
P12V875	NAPW120875HP0MC	2155	1730	1157	875	718	542	410	337	204	149	94.4	60.9	50.8
P12V1220	NAPW121220HP0MC	2807	2314	1596	1220	984	718	519	423	249	181	116	76.1	62.4
P12V1575	NAPW121575HP0MC	3803	3085	2097	1575	1276	931	660	529	301	221	142	92.4	75.1
P12V 2130	NAPW122130HP0MA	5259	4192	2810	2130	1715	1250	901	727	420	307	197	127	105

GNB® INDUSTRIAL POWER



Exide Technologies, with operations in more than 80 countries, is one of the world's largest producers and recyclers of lead-acid batteries. Exide provides a comprehensive and customized range of stored electrical energy solutions.

Based on over 100 years of experience in the development of innovative technologies, Exide is an esteemed partner of OEMs and serves the spare parts market for industrial and transportation applications. The GNB Industrial Power business unit offers an extensive range of storage products and services, including solutions for

telecommunications systems, railway applications, mining, photovoltaic (solar energy), uninterruptible power supply (UPS), electrical power generation and distribution, fork lifts and electric vehicles.

Exide Technologies takes pride in its commitment to a better environment. Its Total Battery Management programme, (an integrated approach to manufacturing, distributing and recycling of lead-acid batteries), has been developed to ensure a safe and responsible life cycle for all of its products.